

OEM miniature resistance thermometer

Models TR31-3 and TR31-K, thread-mounted

WIKA data sheet TE 60.31



further approvals
see page 11

Applications

- Machine building, plant and vessel construction
- Propulsion technology, hydraulics

Special features

- Very compact design, high vibration resistance and fast response time
- With direct sensor output (Pt100, Pt1000 in 2-, 3- or 4-wire connection) or integrated transmitter with 4 ... 20 mA output signal
- Integrated transmitter is individually parameterisable with free-of-charge WIKAsoft-TT PC configuration software
- Sensor element with accuracy class A in accordance with IEC 60751
- EMC conformity in accordance with NAMUR NE21

Description

Resistance thermometers of this series are used as universal thermometers for the measurement of liquid and gaseous media in the range $-50 \dots +250 \text{ }^{\circ}\text{C}$ ($-58 \dots +482 \text{ }^{\circ}\text{F}$). For application in hazardous areas, intrinsically safe versions are available. They can be used for pressures up to 140 bar with 3 mm sensor diameters and up to 270 bar with 6 mm sensor diameters, depending on the instrument version. All electrical components are protected against humidity (IP67 or IP69K) and designed to withstand vibration (20 g, depending on instrument version).

The resistance thermometer is available with direct sensor output or integrated transmitter, which can be configured individually via the PC configuration software WIKAsoft-TT. Measuring range, damping, error signalling per NAMUR NE43 and TAG no. can be adjusted.

Insertion length, process connection, sensor and connection method can each be selected for the respective application within the order information. The model TR31 resistance thermometer consists of a thermowell with a fixed process



Fig. left: Resistance thermometer with M12 x 1, model TR31-3

Fig. centre: Resistance thermometer with directly connected cable, model TR31-K

Fig. right: M12 x 1 adapter to DIN EN 175301-803 angular connector

connection and is screwed directly into the process. The electrical connection depends on the design and is made with an M12 x 1 circular connector or via a directly connected cable. For the M12 x 1 circular connector, an adapter for electrical connection with angular connector per DIN EN 175301-803 form A (patent, property right registered under no. 001370985) is optionally available. As a special feature, the miniature OEM resistance thermometer is also available in customer-specific designs.

Sensor

The sensor is located in the tip of the thermometer.

The resistance thermometers of the series TR31 are designed for direct installation into the process. Using it in an additional thermowell is not advisable.

Sensor diameter in mm	Process connection						
	G ¼ B	G ¾ B	G ½ B	¼ NPT	½ NPT	M12 x 1.5	M20 x 1.5
3	x	x	x	x	x	x	x
6	x	x	x	x	x	x	x

other process connections on request

Sensor tube length										
Sensor diameter in mm	Insertion length U ₁ in mm									
	50	75	100	120	150	200	250	300	350	400
3	x	-	-	-	-	-	-	-	-	-
6	x	x	x	x	x	x	x	x	x	x

Specifications

Thermometer with direct sensor output with Pt100 (model TR31-x-x-Px) or Pt1000 (model TR31-x-x-Sx)	
Temperature range ■ Class A ■ Class B	Without neck tube -30 ... +150 °C (-22 ... +302 °F) With neck tube -30 ... +250 °C (-22 ... +482 °F) ¹⁾ Without neck tube -50 ... +150 °C (-58 ... +302 °F) With neck tube -50 ... +250 °C (-58 ... +482 °F) ¹⁾
Temperature at connector or at the directly connected cable	Max. 85 °C (185 °F)
Measuring element	■ Pt100 (measuring current: 0.1 ... 1.0 mA) ■ Pt1000 (measuring current: 0.1 ... 0.3 mA)
Connection method	■ 2-wire The lead resistance is recorded as an error in the measurement. ■ 3-wire With a cable length of 30 m or longer, measuring deviations can occur. ■ 4-wire The lead resistance can be ignored.
Tolerance value of the measuring element per IEC 60751	■ Class A ■ Class B at 2-wire
Electrical connection	■ M12 x 1 circular connector (4-pin) ■ Directly connected cable
Explosion protection (option)	Intrinsically safe to Ex i (ATEX) gas/dust (for further information see "Further specifications for explosion-protected version")

For detailed specifications for Pt sensors, see Technical information IN 00.17 at www.wika.com.

1) Version with mineral-insulated sheathed cable can be used up to 300 °C (572 °F).

Thermometer with transmitter and 4 ... 20 mA output signal (model TR31-x-x-TT)	
Temperature range	Without neck tube -30 ... +150 °C (-22 ... +302 °F) With neck tube -30 ... +250 °C (-22 ... +482 °F) ^{1) 2)}
Measuring element	Pt1000
Connection method	2-wire
Tolerance value of the measuring element per IEC 60751	Class A
Measuring deviation of the transmitter per IEC 60770	±0.25 K
Total measuring deviation in accordance with IEC 60770	Measuring deviation of the measuring element + the transmitter
Measuring span	Minimum 20 K, maximum 300 K
Basic configuration	Measuring range 0 ... 150 °C (32 ... 302 °F), other measuring ranges are adjustable
Analogue output	4 ... 20 mA, 2-wire
Linearisation	Linear to temperature per IEC 60751
Linearisation error	±0.1 % ³⁾
Switch-on delay, electrical	Max. 4 s (time before the first measured value)
Warming-up period	After approx. 4 minutes, the instrument will function to the specifications (accuracy) given in the data sheet.
Current signals for error signalling	Configurable in accordance with NAMUR NE43 downscale ≤ 3.6 mA upscale ≥ 21.0 mA
Sensor short-circuit	Not configurable, in accordance with NAMUR NE43 downscale ≤ 3.6 mA
Sensor current	< 0.3 mA (self-heating can be ignored)
Load R _A	$R_A \leq (U_B - 10 \text{ V}) / 23 \text{ mA}$ with R _A in Ω and U _B in V
Effect of load	±0.05 % / 100 Ω
Power supply U _B	DC 10 ... 30 V
Max. permissible residual ripple	10 % generated by U _B < 3 % ripple of the output current
Power supply input	Protected against reverse polarity
Power supply effect	±0.025 % / V (depending on the power supply U _B)
Influence of the ambient temperature	0.1 % of span / 10 K T _a
Electromagnetic compatibility (EMC) ⁵⁾	EN 61326 emission (group 1, class B) and interference immunity (industrial application) ⁴⁾ , configuration at 20 % of the full measuring range
Temperature units	Configurable °C, °F, K
Info data	TAG no., description and user message can be stored in transmitter
Configuration and calibration data	Permanently stored
Electrical connection	<ul style="list-style-type: none"> ■ M12 x 1 circular connector (4-pin) ■ Directly connected cable
Explosion protection (option)	Intrinsically safe to Ex i (ATEX) gas/dust (for further information see "Further specifications for explosion-protected version")

Case	
Material	Stainless steel
Ingress protection	IP67 and IP69 per EN/IEC 60529, IP69K per ISO 20653 The stated ingress protection only applies when plugged in using mating connectors that have the appropriate ingress protection. IP67 per EN/IEC 60529
<ul style="list-style-type: none"> ■ Case with connected connector or directly connected cable ⁶⁾ ■ Coupler connector, not connected 	
Weight in kg	Approx. 0.2 ... 0.7 (depending on version)
Dimensions	See "Dimensions in mm"

Readings in % refer to the measuring span

1) Version with mineral-insulated sheathed cable can be used up to 300 °C (572 °F).

2) The temperature transmitter should therefore be protected from temperatures over 85 °C (185 °F).

3) ±0.2 % for measuring ranges with a lower limit less than 0 °C (32 °F)

4) Use resistance thermometers with shielded cable, and ground the shield on at least one end of the lead, if the lines are longer than 30 m or leave the building. The instrument must be operated grounded.

5) During transient interferences (e.g. burst, surge, ESD) take into account an increased measuring deviation of up to 2 %.

6) Not tested at UL

Ambient conditions	
Ambient temperature range ■ M12 x 1 circular connector Model TR31-3-x-TT Models TR31-3-x-Px, TR31-3-x-Sx ■ Directly connected cable, model TR31-K-x-xx	-40 ... +85 °C (-40 ... +185 °F) -50 ... +85 °C (-58 ... +185 °F) -20 ... +80 °C (-4 ... +176 °F)
Storage temperature range ■ M12 x 1 circular connector, model TR31-3-x-xx ■ Directly connected cable, model TR31-K-x-xx	-40 ... +85 °C (-40 ... +185 °F) -20 ... +80 °C (-4 ... +176 °F)
Climate class per IEC 60654-1 ■ M12 x 1 circular connector Model TR31-3-x-TT Models TR31-3-x-Px, TR31-3-x-Sx ■ Directly connected cable, model TR31-K-x-xx	Cx (-40 ... +85 °C or -40 ... +185 °F, 5 ... 95 % r. h.) Cx (-50 ... +85 °C or -58 ... +185 °F, 5 ... 95 % r. h.) Cx (-20 ... +80 °C or -4 ... +176 °F, 5 ... 95 % r. h.)
Maximum permissible humidity per IEC 60068-2-30 var. 2	100 % r. h., condensation allowed
Maximum operating pressure ^{7) 8)}	140 bar with 3 mm sensor diameter 270 bar with 6 mm sensor diameter
Vibration resistance per IEC 60751	10 ... 2,000 Hz, 20 g ⁷⁾
Shock resistance per IEC 60068-2-27	50 g, 6 ms, 3 axis, 3 faces, 3 times for each face
Salt fog	IEC 60068-2-11

Readings in % refer to the measuring span

7) Dependent on the instrument version

8) Reduced operating pressure when using a compression fitting: Stainless steel: max. 100 bar
PTFE: max. 8 bar

Conditions for outdoor use (for UL approval only)

- The instrument is suitable for applications with pollution degree 3.
- The power supply must be suitable for operation above 2,000 m should the temperature transmitter be used at this altitude.
- The instrument shall be installed in locations sheltered from the weather.
- The instrument shall be installed "sun/UV radiation protected".

Further specifications for explosion-protected version (optional)

■ Thermometer with transmitter and 4 ... 20 mA output signal (model TR31-x-x-TT)

Marking:

Hazardous gas atmosphere	Temperature class	Ambient temperature range (T_a)	Maximum surface temperature (T_{max}) at the sensor or thermowell tip
II 1G Ex ia IIC T1 - T6 Ga II 1/2G Ex ia IIC T1 - T6 Ga/Gb II 2G Ex ia IIC T1 - T6 Gb	T6	-40 ... +45 °C	T_M (medium temperature) + self-heating (15 K) Pay attention to the specific conditions for safe use.
	T5	-40 ... +60 °C	
	T4	-40 ... +85 °C	
	T3	-40 ... +85 °C	
	T2	-40 ... +85 °C	
	T1	-40 ... +85 °C	

Hazardous dust atmosphere	Power P_i	Ambient temperature range (T_a)	Maximum surface temperature (T_{max}) at the sensor or thermowell tip
II 1D Ex ia IIIC T135 °C Da II 1/2D Ex ia IIIC T135 °C Da/Db II 2D Ex ia IIIC T135 °C Db	750 mW	-40 ... +40 °C	T_M (medium temperature) + self-heating (15 K) Pay attention to the specific conditions for safe use.
	650 mW	-40 ... +70 °C	
	550 mW	-40 ... +85 °C	

Safety-related maximum values for the current loop circuit (+ and - connections):

Parameters	Hazardous gas atmosphere	Hazardous dust atmosphere
Terminals	+ / -	+ / -
Voltage U_i	DC 30 V	DC 30 V
Current I_i	120 mA	120 mA
Power P_i	800 mW	750/650/550 mW
Effective internal capacitance C_i	29.7 nF	29.7 nF
Effective internal inductance L_i	Negligible	Negligible
Maximum self-heating at the sensor or thermowell tip	15 K	15 K

■ Thermometer with direct sensor output with Pt100 (model TR31-x-x-Px) or Pt1000 (model TR31-x-x-Sx)

Marking:

Marking	Temperature class	Ambient temperature range (T _a)	Maximum surface temperature (T _{max}) at the sensor or thermowell tip
II 1G Ex ia IIC T1 - T6 Ga II 1/2G Ex ia IIC T1 - T6 Ga/Gb II 2G Ex ia IIC T1 - T6 Gb	T6	-50 ... +80 °C	T _M (medium temperature) + self-heating Pay attention to the specific conditions for safe use.
	T5	-50 ... +85 °C	
	T4	-50 ... +85 °C	
	T3	-50 ... +85 °C	
	T2	-50 ... +85 °C	
	T1	-50 ... +85 °C	

Marking	Power P _i	Ambient temperature range (T _a)	Maximum surface temperature (T _{max}) at the sensor or thermowell tip
II 1D Ex ia IIIC T135 °C Da II 1/2D Ex ia IIIC T135 °C Da/Db II 2D Ex ia IIIC T135 °C Db	750 mW	-50 ... +40 °C	T _M (medium temperature) + self-heating Pay attention to the specific conditions for safe use.
	650 mW	-50 ... +70 °C	
	550 mW	-50 ... +85 °C	

Safety-related maximum values for the current loop circuit (connections in accordance with pin assignment 1 - 4):

Parameters	Gas applications	Dust applications
Terminals	1 - 4	1 - 4
Voltage U _i	DC 30 V	DC 30 V
Current I _i	550 mA	250 mA
Power P _i	1.500 mW	750/650/550 mW
Effective internal capacitance C _i	Negligible	Negligible
Effective internal inductance L _i	Negligible	Negligible
Maximum self-heating at the sensor or thermowell tip	(R _{th}) = 335 K/W	(R _{th}) = 335 K/W

Configuration software WIKAsoft-TT

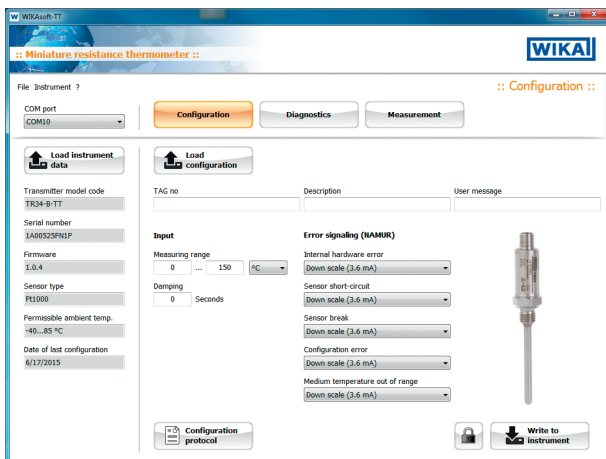

Configuration software (multilingual) as a download from www.wika.com

Dimensions in mm



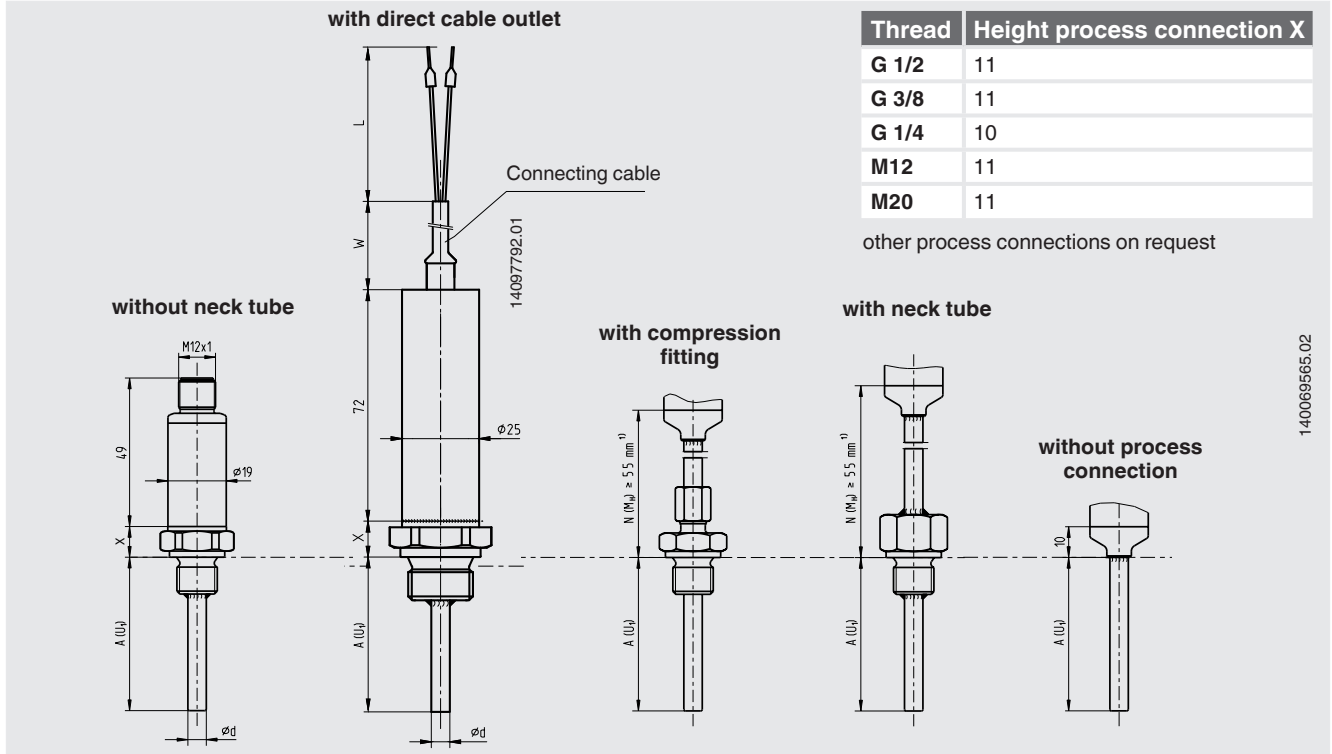

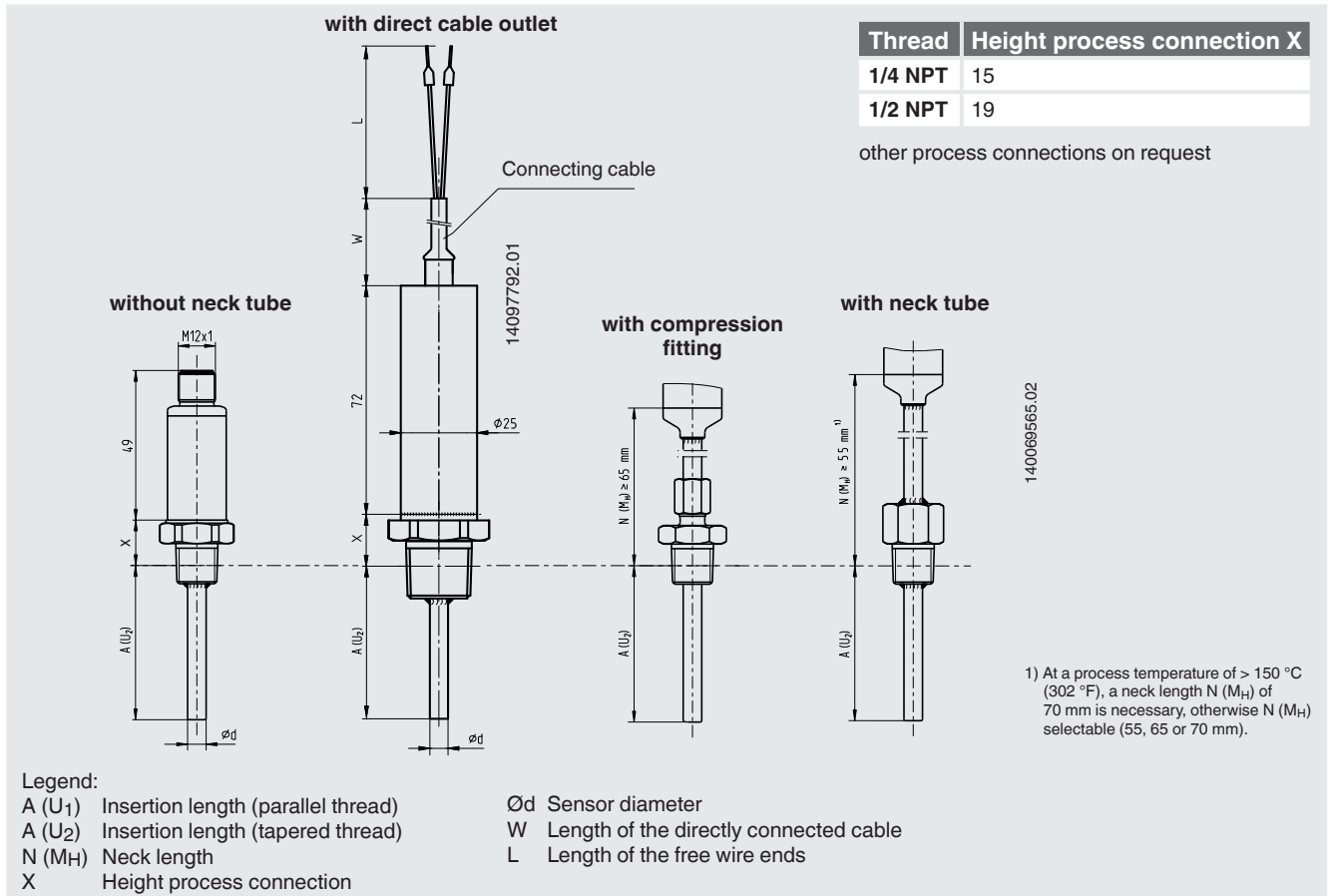

Process connection with parallel threads (or without process connection)

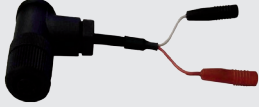

Process connection with tapered thread

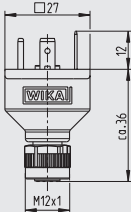
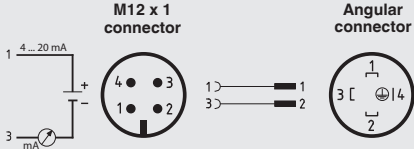

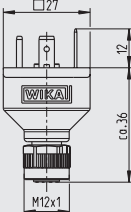
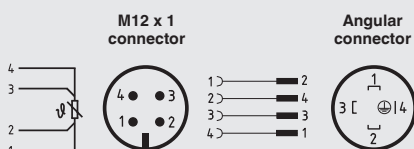
Accessories

Model	Special features	Order no.
Programming unit Model PU-548 	<ul style="list-style-type: none"> ■ Easy to use ■ LED status display ■ Compact design ■ No further voltage supply needed, neither for the programming unit nor for the transmitter <p>(replaces programming unit model PU-448)</p>	14231581
Adapter cable M12 to PU-548 	Adapter cable for the connection of a model TR31 resistance thermometer to the model PU-548 programming unit	14003193
Crocodile clip set 	Crocodile clips for the connection of the model TR31-K resistance thermometer with directly connected cable with the model PU-548 programming unit	14097967
M12 x 1 transmitter adapter to angular connector DIN EN 175301-803 (yellow female connector element)  	Adapter for the connection of a resistance thermometer with a DIN EN 175301-803 form A angular connector with a 4 ... 20 mA output signal (data sheet AC 80.17)  <p>Case: PA Ambient temperature: -40 ... +115 °C Union nut: zinc diecast Contacts: copper-zinc alloy, tin-plated Dielectric strength: 500 V Ingress protection: IP65</p>	14069503
M12 x 1 Pt adapter to angular connector DIN EN 175301-803 (black female connector element)  	Adapter for the connection of the resistance thermometer with a DIN EN 175301-803 form A angular connector with direct resistance output signal (data sheet AC 80.17)  <p>Case: PA Ambient temperature: -40 ... +115 °C Union nut: zinc diecast Contacts: copper-zinc alloy, tin-plated Dielectric strength: 500 V Ingress protection: IP65</p>	14061115
Angular connector 	Per DIN EN 175301-803 form A	11427567
Sealing for angular connector 	For use with angular connector DIN EN 175301-803-A EPDM, brown	11437902
M12 connection cable	Cable socket straight, 4-pin, ingress protection IP67 <ul style="list-style-type: none"> ■ Temperature range -20 ... +80 °C ■ Suitable for hazardous areas 	Cable length 2 m 14086880
		Cable length 5 m 14086883
	Cable socket straight, 4-pin, ingress protection IP69K <ul style="list-style-type: none"> ■ Temperature range -40 ... +80 °C ■ Not for hazardous areas 	Cable length 3 m 14137167
		Cable length 5 m 14137168
	Angled socket, 4-pin, ingress protection IP67 <ul style="list-style-type: none"> ■ Temperature range -20 ... +80 °C ■ Suitable for hazardous areas 	Cable length 2 m 14086889
		Cable length 5 m 14086891
	Angled socket, 4-pin, ingress protection IP69K <ul style="list-style-type: none"> ■ Temperature range -40 ... +80 °C ■ Not for hazardous areas 	Cable length 3 m 14137169
		Cable length 5 m 14137170

Connecting PU-548 programming unit

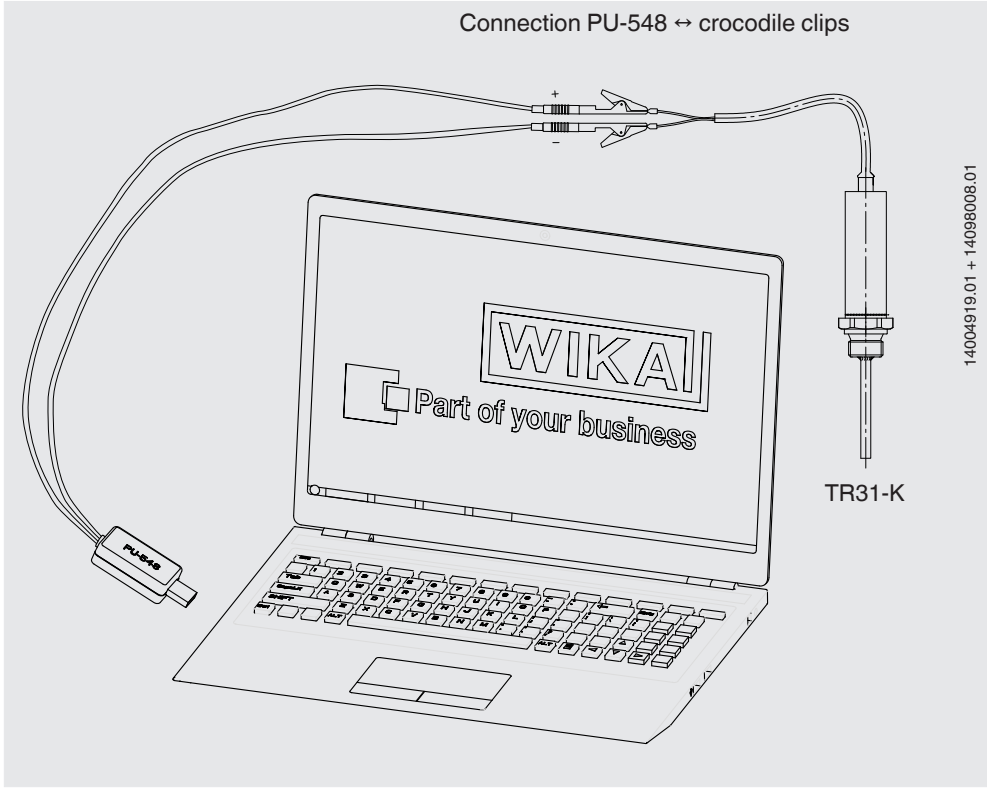
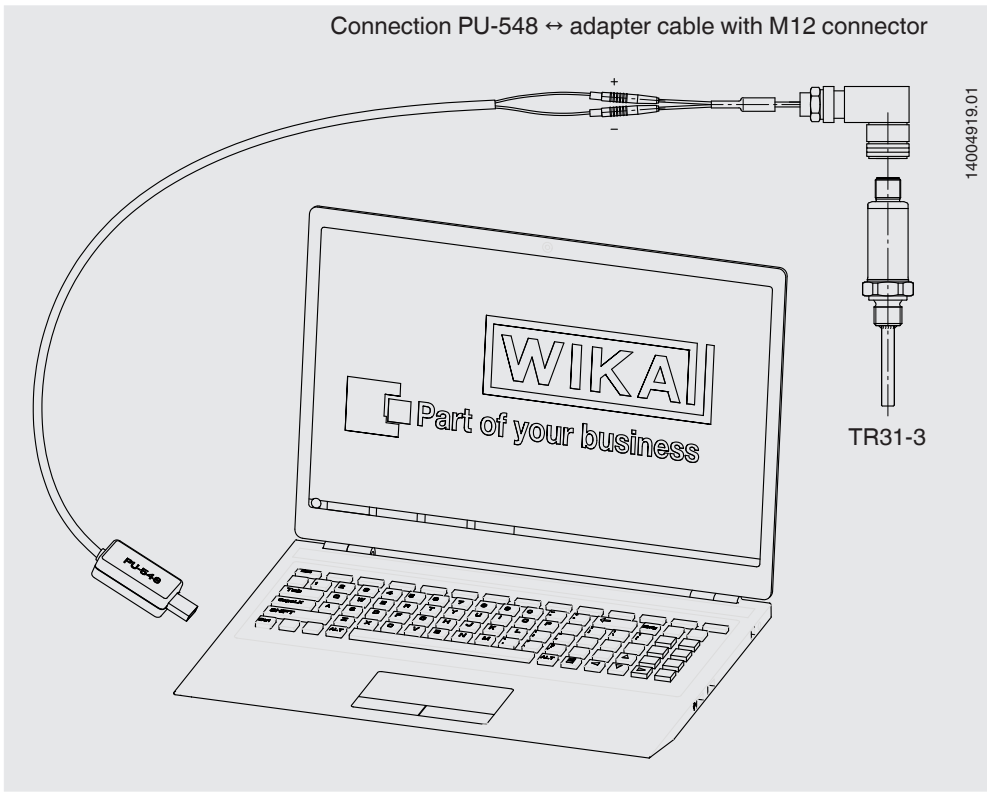

(predecessor, programming unit model PU-448, also compatible)

Electrical connection

■ M12 x 1 circular connector (4-pin)

Output signal 4 ... 20 mA

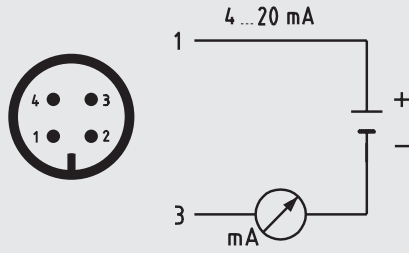

Pin	Signal	Description
1	L+	10 ... 30 V
2	VQ	not connected
3	L-	0 V
4	C	not connected

Pt100 and Pt1000 output signal

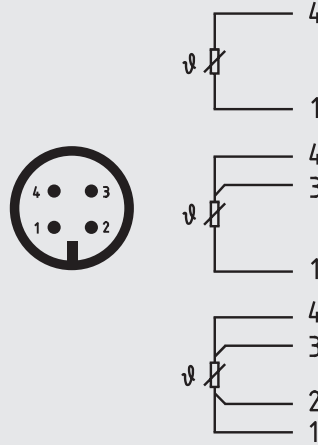

■ Directly connected cable

Output signal 4 ... 20 mA

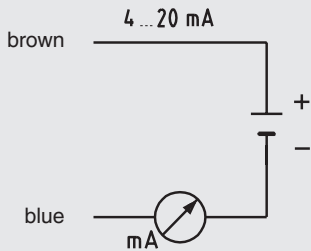

Pin	Signal	Description
Brown	L+	10 ... 30 V
Blue	L-	0 V

Pt100 and Pt1000 output signal

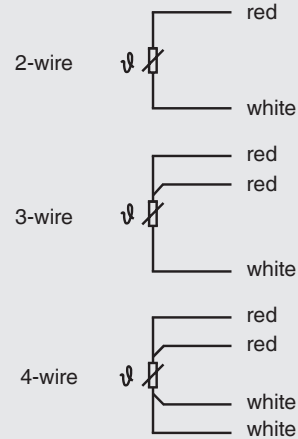





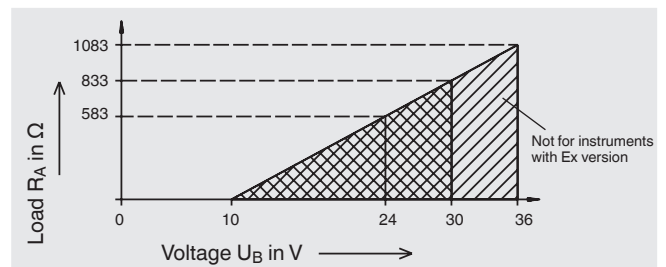





Load diagram

The permissible load depends on the loop supply voltage. For communication with the instrument with programming unit PU-548, a max. load of 350 Ω is admissible.



Approvals

Logo	Description	Country
	EU declaration of conformity <ul style="list-style-type: none"> ■ EMC directive ¹⁾ EN 61326 emission (group 1, class B) and interference immunity (industrial application) ■ RoHS directive ■ ATEX directive (option) <ul style="list-style-type: none"> II 1G Ex ia IIC T1 - T6 Ga II 1/2G Ex ia IIC T1 - T6 Ga/Gb II 2G Ex ia IIC T1 - T6 Gb II 1D Ex ia IIIC T135 °C Da II 1/2D Ex ia IIIC T135 °C Da/Db II 2D Ex ia IIIC T135 °C Db 	European Union
	IECEx (option) - in conjunction with ATEX Hazardous areas	International
	CSA (option) <ul style="list-style-type: none"> ■ Safety (e.g. electr. safety, overpressure, ...) ■ Hazardous areas 	USA and Canada
	UL (Option) Safety (e.g. electr. safety, overpressure, ...)	USA and Canada
	EAC (option) <ul style="list-style-type: none"> ■ EMC directive ¹⁾ ■ Hazardous areas 	Eurasian Economic Community
	GOST (option) Metrology, measurement technology	Russia
	KazInMetr (option) Metrology, measurement technology	Kazakhstan
-	MTSCHS (option) Permission for commissioning	Kazakhstan
	UkrSEPRO (option) Metrology, measurement technology	Ukraine
	DNOP - MakNII (option) <ul style="list-style-type: none"> ■ Mining ■ Hazardous areas 	Ukraine
	Uzstandard (option) Metrology, measurement technology	Uzbekistan
	NEPSI (option) Hazardous areas	China

1) Only for built-in transmitter

Certificates (option)

Certification type	Measuring accuracy	Material certificate
2.2 test report	x	x
3.1 inspection certificate	x	x
DKD/DAkkS calibration certificate	x	-

The different certifications can be combined with each other.

Approvals and certificates, see website

Patents, property rights

M12 x 1 adapter to DIN EN 175301-803 angular connector,
registered under no. 001370985

Ordering information

Model / Design / Output signal / Transmitter temperature unit / Process temperature / Transmitter initial value / Transmitter end value / Process connection / Sensor diameter / Insertion length A (U₁) or A (U₂) / Neck length N (M_H) / Accessories / Certificates

© 09/2013 WIKA Alexander Wiegand SE & Co. KG, all rights reserved.
The specifications given in this document represent the state of engineering at the time of publishing.
We reserve the right to make modifications to the specifications and materials.

